



Ventiladores helicoidales murales o tubulares, de gran robustez



HCH



HCT



Construcción robusta

Ventiladores helicoidales murales o tubulares, versión PL equipados con hélice de plástico y versión AL equipados con hélice de aluminio.

Ventilador:

- Dirección aire motor-hélice
- Hélices versión PL en poliamida 6 reforzada con fibra de vidrio y versión AL en fundición de aluminio. Los modelos HCT-40-2T y HCT-45-2T sólo en versión AL
- HCH: Aro soporte en chapa de acero
- HCT: Envoltente tubular en chapa de acero

Motor:

- Motores clase F, con rodamientos a bolas, protección IP55, excepto modelos monofásicos desde el tamaño 45 hasta el tamaño 56, protección IP54. De 1 ó 2 velocidades según modelo
- Monofásicos 230V.-50Hz., y trifásicos 230/400V.-50Hz.(hasta 5,5CV.) y 400/690V.-50Hz.(potencias superiores a 5,5CV.)
- Temperatura de trabajo : -25°C.+ 50°C.

Acabado: Anticorrosivo en resina de poliéster polimerizada a 190°C, previo desengrase alcalino y pretratamiento libre de fosfatos.

Bajo demanda:

- Dirección aire hélice-motor.
- Hélices reversibles 100%.
- Bobinados especiales para diferentes tensiones.
- Certificación ATEX Categoría 2 (ver serie HCT/ATEX)

Características técnicas

Modelo	Velocidad (r/min)	Intensidad máxima admisible (A)			Potencia instalada (kW)	Caudal máximo (m3/h)	Nivel de presión sonora dB(A)	Peso Aprox. Kg.	
		230V	400V	690V				HCH	HCT
HCT-25-2T	2775	0,58	0,34		0,12	1940	64		7
HCT-25-2M	2775	0,90			0,12	1940	64		7
HCT-25-4T	1445	0,57	0,33		0,06	980	50		7
HCT-25-4M	1445	0,58			0,06	980	50		7
HCT-31-2T	2750	1,12	0,65		0,18	2900	70		8
HCT-31-2M	2700	1,45			0,18	2900	70		8
HCT-31-4T	1450	0,60	0,34		0,08	1550	52		8
HCT-31-4M	1450	0,65			0,08	1550	52		8
HCH-35-2T	HCT-35-2T	2800	2,15	1,25	0,37	5750	77	9	12
	* HCT-35-2M	2750	2,90		0,37	5750	77		12
HCH-35-4T	HCT-35-4T	1440	0,64	0,37	0,10	3100	59	7	10
	HCT-35-4M	1440	0,67		0,10	3100	59		10
HCH-40-2T-1,5	HCT-40-2T-1,5	2900	4,68	2,70	1,10	8750	84	17	25
HCH-40-4T-0,33	HCT-40-4T-0,33	1450	1,58	0,91	0,25	5100	64	13	21
	HCT-45-2T-2	2900	5,89	3,40	1,50	10300	86		31
	HCT-45-2T-3	2900	8,23	4,75	2,20	12800	88		34
	HCT-45-2/4T-3	2910/1420	-	5,00/1,60	2,20/0,60	12800/6400	88/73		33
HCH-45-4T-0,5	HCT-45-4T-0,5	1450	2,07	1,20	0,37	7100	68	15	24
HCH-45-4M-0,5	HCT-45-4M-0,5	1450	3,10		0,37	7100	68	15	24
HCH-45-6T-0,33		950	1,47	0,85	0,25	4750	55	14	
HCH-45-6M-0,33		950	1,30		0,25	4750	55	15	
	HCT-50-4T-0,75	1450	3,00	1,73	0,55	10300	70		28

* No regulable

**Características técnicas**

Modelo	Velocidad (r/min)	Intensidad máxima admisible (A)			Potencia instalada (kW)	Caudal máximo (m ³ /h)	Nivel de presión sonora dB(A)	Peso Aprox. Kg.	
		230V	400V	690V				HCH	HCT
HCH-56-4T-0,75	HCT-56-4T-0,75	1450	3,12	1,80	0,55	11000	72	21	33
HCH-56-4M-0,75	HCT-56-4M-0,75	1450	4,40		0,55	11000	72	21	33
HCH-56-4T-1	HCT-56-4T-1	1450	3,46	2,00	0,75	12900	73	22	34
HCH-56-4/8T-1	HCT-56-4/8T-1	1430/710	-	2,15/0,90	0,75/0,15	12900/6450	73/58	23	35
HCH-56-4T-1,5	HCT-56-4T-1,5	1450	5,20	3,00	1,10	14000	74	26	37
HCH-56-4/8T-1,5	HCT-56-4/8T-1,5	1440/710	-	3,15/1,30	1,10/0,25	14000/7000	74/59	24	35
HCH-56-4T-2	HCT-56-4T-2	1450	6,41	3,70	1,50	15300	75	28	39
HCH-56-4/8T-2	HCT-56-4/8T-2	1420/700	-	3,50/1,50	1,50/0,37	15300/7650	75/60	28	39
HCH-56-6T-0,33	HCT-56-6T-0,33	950	1,47	0,85	0,25	8400	61	18	30
HCH-56-6M-0,33	HCT-56-6M-0,33	950	1,85		0,25	8400	61	19	31
HCH-56-6T-0,5	HCT-56-6T-0,5	950	2,11	1,22	0,37	9300	61	20	32
HCH-56-6T-0,75	HCT-56-6T-0,75	950	2,96	1,71	0,55	10000	62	22	34
HCH-63-4T-1	HCT-63-4T-1	1450	3,46	2,00	0,75	14100	73	27	42
HCH-63-4/8T-1	HCT-63-4/8T-1	1430/710	-	2,15/0,90	0,75/0,15	14100/7050	73/58	27	43
HCH-63-4T-1,5	HCT-63-4T-1,5	1450	5,20	3,00	1,10	17000	74	30	45
HCH-63-4/8T-1,5	HCT-63-4/8T-1,5	1440/710	-	3,15/1,30	1,10/0,25	17000/8500	74/59	29	44
HCH-63-4T-2	HCT-63-4T-2	1450	6,41	3,70	1,50	18900	75	33	48
HCH-63-4/8T-2	HCT-63-4/8T-2	1420/700	-	3,50/1,50	1,50/0,37	18900/9450	75/60	32	48
HCH-63-4T-3	HCT-63-4T-3	1450	8,49	4,9	2,20	22000	76	41	57
HCH-63-4/8T-3	HCT-63-4/8T-3	1430/710	-	4,90/1,70	2,20/0,45	22000/11000	76/61	38	54
HCH-63-4T-4	HCT-63-4T-4	1450	11,78	6,80	3,00	25200	77	43	59
HCH-63-4/8T-4	HCT-63-4/8T-4	1430/710	-	6,50/2,30	3,00/0,60	25200/12600	77/62	42	57
HCH-63-6T-0,5	HCT-63-6T-0,5	950	2,11	1,22	0,37	12000	64	25	40
HCH-63-6M-0,5	HCT-63-6M-0,5	950	2,80		0,37	12000	64	25	40
HCH-63-6T-0,75	HCT-63-6T-0,75	950	2,96	1,71	0,55	12600	65	27	42
HCH-63-6T-1	HCT-63-6T-1	950	3,91	2,26	0,75	13800	66	33	48
HCH-63-6/12T-1	HCT-63-6/12T-1	935/435	-	2,20/0,87	0,75/0,15	13800/6900	66/51	32	47
HCH-71-4T-1,5	HCT-71-4T-1,5	1450	5,20	3,00	1,10	19900	78	33	52
HCH-71-4/8T-1,5	HCT-71-4/8T-1,5	1440/710	-	3,15/1,30	1,10/0,25	19900/9950	78/63	32	51
HCH-71-4T-2	HCT-71-4T-2	1450	6,41	3,70	1,50	21000	79	36	55
HCH-71-4/8T-2	HCT-71-4/8T-2	1420/700	-	3,50/1,50	1,50/0,37	21000/10500	79/64	35	54
HCH-71-4T-3	HCT-71-4T-3	1450	8,49	4,90	2,20	24000	81	45	64
HCH-71-4/8T-3	HCT-71-4/8T-3	1430/710	-	4,90/1,70	2,20/0,45	24000/12000	81/66	42	61
HCH-71-4T-4	HCT-71-4T-4	1450	11,78	6,80	3,00	29400	82	47	66
HCH-71-4/8T-4	HCT-71-4/8T-4	1430/710	-	6,50/2,30	3,00/0,60	29400/14700	82/67	46	64
HCH-71-6T-0,75	HCT-71-6T-0,75	950	2,96	1,71	0,55	15000	67	29	49
HCH-71-6M-0,75	HCT-71-6M-0,75	950	3,80		0,55	15000	67	29	49
HCH-71-6T-1	HCT-71-6T-1	950	3,91	2,26	0,75	17200	68	36	55
HCH-71-6/12T-1	HCT-71-6/12T-1	950/435	-	2,26/0,87	0,75/0,15	17200/8600	68/53	35	54
HCH-71-6T-1,5	HCT-71-6T-1,5	950	5,00	2,89	1,10	21100	69	38	57
HCH-71-6/12T-1,5	HCT-71-6/12T-1,5	950/470	-	3,00/1,15	1,10/0,18	21100/10550	69/54	37	56
HCH-80-4T-3	HCT-80-4T-3	1450	8,49	4,90	2,20	29500	82	53	72
HCH-80-4/8T-3	HCT-80-4/8T-3	1430/710	-	4,90/1,70	2,20/0,45	29500/14750	82/67	50	69
HCH-80-4T-4	HCT-80-4T-4	1450	11,78	6,80	3,00	37000	83	55	74
HCH-80-4/8T-4	HCT-80-4/8T-4	1430/710	-	6,50/2,30	3,00/0,60	37000/18500	83/68	54	73
HCH-80-4T-5,5	HCT-80-4T-5,5	1450	15,24	8,80	4,00	40500	84	60	79
HCH-80-4/8T-5,5	HCT-80-4/8T-5,5	1430/710	-	8,80/2,90	4,00/0,80	40500/20250	84/69	66	85
HCH-80-6T-1	HCT-80-6T-1	950	4,16	2,40	0,75	23000	71	44	64
HCH-80-6/12T-1	HCT-80-6/12T-1	950/435	-	2,40/0,87	0,75/0,15	23000/11500	71/56	43	63
HCH-80-6T-1,5	HCT-80-6T-1,5	950	5,80	3,35	1,10	26000	72	46	66
HCH-80-6/12T-1,5	HCT-80-6/12T-1,5	950/470	-	3,35/1,15	1,10/0,18	26000/13000	72/57	45	65
HCH-80-6T-2	HCT-80-6T-2	950	7,62	4,40	1,50	29700	73	52	71



Características técnicas

Modelo		Velocidad (r/min)	Intensidad máxima admisible (A)			Potencia instalada (kW)	Caudal máximo (m3/h)	Nivel de presión sonora dB(A)	Peso Aprox. Kg.	
			230V	400V	690V				HCH	HCT
HCH-80-6/12T-2	HCT-80-6/12T-2	970/470	-	4,60/1,90	1,50/0,25	29700/14850	73/58	62	81	
HCH-80-6T-3	HCT-80-6T-3	950	9,35	5,40	2,20	33500	74	57	76	
HCH-80-6/12T-3	HCT-80-6/12T-3	940/470	-	5,60/2,20	2,20/0,37	33500/16750	74/59	62	81	
HCH-80-8T-0,5	HCT-80-8T-0,5	720	2,77	1,60	0,37	16500	69	43	63	
HCH-80-8T-0,75	HCT-80-8T-0,75	720	3,26	1,88	0,55	19500	70	45	65	
HCH-80-8T-1	HCT-80-8T-1	720	4,23	2,44	0,75	22000	71	50	69	
HCH-90-4T-4	HCT-90-4T-4	1450	11,95	6,90	3,00	40000	87	62	90	
HCH-90-4/8T-4	HCT-90-4/8T-4	1430/710	-	6,90/2,30	3,00/0,60	40000/20000	87/72	61	88	
HCH-90-4T-5,5	HCT-90-4T-5,5	1450	15,24	8,80	4,00	46500	89	67	95	
HCH-90-4/8T-5,5	HCT-90-4/8T-5,5	1450/710	-	8,80/2,90	4,00/0,80	46500/23250	89/74	73	101	
HCH-90-4T-7,5	HCT-90-4T-7,5	1450	-	12,40 7,20	5,50	51000	91	83	109	
HCH-90-4/8T-7,5	HCT-90-4/8T-7,5	1460/725	-	12,50/4,10	5,50/1,10	51000/25500	91/76	93	119	
HCH-90-4T-10	HCT-90-4T-10	1450	-	15,60 9,00	7,50	54700	92	94	120	
HCH-90-4/8T-10	HCT-90-4/8T-10	1460/725	-	15,30/5,40	7,50/1,50	54700/27350	92/77	98	124	
HCH-90-6T-2	HCT-90-6T-2	950	7,62	4,40	1,50	34300	77	59	87	
HCH-90-6/12T-2	HCT-90-6/12T-2	970/470	-	4,60/1,90	1,50/0,25	34300/17150	77/62	69	97	
HCH-90-6T-3	HCT-90-6T-3	950	9,35	5,40	2,20	38000	78	64	92	
HCH-90-6/12T-3	HCT-90-6/12T-3	940/470	-	5,60/2,20	2,20/0,37	38000/19000	78/63	69	97	
HCH-90-6T-4	HCT-90-6T-4	950	12,66	7,31	3,00	42400	79	88	114	
HCH-90-6/12T-4	HCT-90-6/12T-4	960/470	-	8,20/3,40	3,00/0,55	42400/21200	79/64	87	113	
HCH-90-8T-1	HCT-90-8T-1	720	4,23	2,44	0,75	22500	71	57	85	
HCH-90-8T-1,5	HCT-90-8T-1,5	720	5,99	3,46	1,10	24000	72	60	88	
HCH-90-8T-2	HCT-90-8T-2	720	7,36	4,25	1,50	26000	73	71	99	
HCH-90-8T-3	HCT-90-8T-3	720	9,75	5,63	2,20	30000	74	98	124	
HCH-100-4T-7,5	HCT-100-4T-7,5	1450	-	11,90 6,90	5,50	54000	92	91	104	
HCH-100-4/8T-7,5	HCT-100-4/8T-7,5	1460/725	-	12,50/4,10	5,50/1,10	54000/27000	92/77	101	114	
HCH-100-4T-10	HCT-100-4T-10	1450	-	16,90 9,80	7,50	63000	93	102	131	
HCH-100-4/8T-10	HCT-100-4/8T-10	1460/725	-	16,90/5,40	7,50/1,50	63000/31500	93/78	106	135	
HCH-100-4T-15	HCT-100-4T-15	1460	-	22,50 13,00	11,00	68000	94	125	160	
HCH-100-4/8T-15	HCT-100-4/8T-15	1460/735	-	21,00/7,40	10,50/2,20	68000/34000	94/79	125	160	
HCH-100-4T-20	HCT-100-4T-20	1455	-	30,00 17,30	15,00	72000	95	144	179	
HCH-100-4/8T-20	HCT-100-4/8T-20	1460/735	-	30,00/9,50	15,50/2,70	72000/36000	95/80	140	175	
HCH-100-6T-3	HCT-100-6T-3	950	10,05	5,80	2,20	43000	82	72	103	
HCH-100-6/12T-3	HCT-100-6/12T-3	940/470	-	5,80/2,20	2,20/0,37	43000/21500	82/67	77	108	
HCH-100-6T-4	HCT-100-6T-4	950	12,66	7,31	3,00	47000	83	96	125	
HCH-100-6/12T-4	HCT-100-6/12T-4	960/470	-	8,20/3,40	3,00/0,55	47000/23500	83/68	95	124	
HCH-100-6T-5,5	HCT-100-6T-5,5	950	15,76	9,10	4,00	53000	84	104	133	
HCH-100-6/12T-5,5	HCT-100-6/12T-5,5	970/480	-	11,00/4,00	4,00/0,65	53000/26500	84/69	100	129	
HCH-100-8T-1,5	HCT-100-8T-1,5	720	6,32	3,65	1,10	32500	76	67	99	
HCH-100-8T-2	HCT-100-8T-2	720	7,36	4,25	1,50	33900	77	79	110	
HCH-100-8T-3	HCT-100-8T-3	720	9,75	5,63	2,20	35000	77	106	135	
HCH-100-8T-4	HCT-100-8T-4	720	12,51	7,22	3,00	38000	78	114	143	

**Características acústicas**

Los valores indicados, se determinan mediante medidas de nivel de presión y potencia sonora en dB(A) obtenidas en campo libre a una distancia equivalente a dos veces la envergadura del ventilador más el diámetro de la hélice, con un mínimo de 1,5 mts.

Espectro de potencia sonora Lw(A) en dB(A) por banda de frecuencia en Hz.

Modelo	63	125	250	500	1000	2000	4000	8000	Modelo	63	125	250	500	1000	2000	4000	8000
25-2	35	50	69	68	69	68	63	54	80-8-3 (2v)	44	64	72	77	79	76	69	58
25-4	21	36	55	54	55	54	49	40	80-4-4	60	80	88	93	95	92	85	74
31-2	41	56	75	74	75	74	69	60	80-8-4 (2v)	45	65	73	78	80	77	70	59
31-4	23	38	57	56	57	56	51	42	80-4-5,5	61	81	89	94	96	93	86	75
35-2	48	63	82	81	82	81	76	67	80-8-5,5 (2v)	46	66	74	79	81	78	71	60
35-4	30	45	64	63	64	63	58	49	80-6-1	48	68	76	81	83	80	73	62
40-2	49	66	78	86	91	91	87	80	80-12-1 (2v)	33	53	61	66	68	65	58	47
40-4	29	46	58	66	71	71	67	60	80-6-1,5	49	69	77	82	84	81	74	63
45-2-2	51	68	80	88	93	93	89	82	80-12-1,5 (2v)	34	54	62	67	69	66	59	48
45-2-3	53	70	82	90	95	95	91	84	80-6-2	50	70	78	83	85	82	75	64
45-4-3 (2v)	38	55	67	75	80	80	76	69	80-12-2 (2v)	35	55	63	68	70	67	60	49
45-4-0,5	33	50	62	70	75	75	71	64	80-6-3	51	71	79	84	86	83	86	65
45-6	20	37	49	57	62	62	58	51	80-12-3 (2v)	36	56	64	69	71	68	61	50
50-4	37	54	67	74	79	80	75	68	80-8-0,5	46	66	74	79	81	78	71	60
56-4-0,75	47	67	75	80	82	79	72	61	80-8-0,75	47	67	75	80	82	79	72	61
56-4-1	48	68	76	81	83	80	73	62	80-8-1	48	68	76	81	83	80	73	62
56-8-1 (2v)	33	53	61	66	68	65	58	47	90-4-4	65	86	93	98	101	97	90	79
56-4-1,5	49	69	77	82	84	81	74	63	90-8-4 (2v)	50	71	78	83	86	82	75	64
56-8-1,5 (2v)	34	54	62	67	69	66	59	48	90-4-5,5	67	88	95	100	103	99	92	81
56-4-2	50	70	78	83	85	82	75	64	90-8-5,5 (2v)	52	73	80	85	88	84	77	66
56-8-2 (2v)	35	55	63	68	70	67	60	49	90-4-7,5	69	90	97	102	105	101	94	83
56-6-0,33	36	56	64	69	71	68	61	50	90-8-7,5 (2v)	54	75	82	87	90	86	79	68
56-6-0,5	36	56	64	69	71	68	61	50	90-4-10	70	91	98	103	106	102	95	84
56-6-0,75	37	57	65	70	72	69	62	51	90-8-10 (2v)	55	76	83	88	91	87	80	69
63-4-1	50	70	78	83	85	82	75	64	90-6-2	55	76	83	88	91	87	80	69
63-8-1 (2v)	35	55	63	68	70	67	60	49	90-12-2 (2v)	40	61	68	73	76	72	65	54
63-4-1,5	51	71	79	84	86	83	76	65	90-6-3	56	77	84	89	92	88	81	70
63-8-1,5 (2v)	36	56	64	69	71	68	61	50	90-12-3 (2v)	41	62	69	74	77	73	66	55
63-4-2	52	72	80	85	87	84	77	66	90-6-4	57	78	85	90	93	89	82	71
63-8-2 (2v)	37	57	65	70	72	69	62	51	90-12-4 (2v)	42	63	70	75	78	74	67	56
63-4-3	53	73	81	86	88	85	78	67	90-8-1	49	70	77	82	85	81	74	63
63-8-3 (2v)	38	58	66	71	73	70	63	52	90-8-1,5	50	71	78	83	86	82	75	64
63-4-4	54	74	82	87	89	86	79	68	90-8-2	51	72	79	84	87	83	76	65
63-8-4 (2v)	39	59	67	72	74	71	64	53	90-8-3	52	73	80	85	88	84	77	66
63-6-0,5	41	61	69	74	76	73	66	55	100-4-7,5	72	92	100	105	107	104	97	86
63-6-0,75	42	62	70	75	77	74	67	56	100-8-7,5 (2v)	57	77	85	90	92	89	82	71
63-6-1	43	63	71	76	78	75	68	57	100-4-10	73	93	101	106	108	105	98	87
63-12-1 (2v)	28	48	56	61	63	60	53	42	100-8-10 (2v)	58	78	86	91	93	90	83	72
71-4-1,5	55	75	83	88	90	87	80	69	100-4-15	74	94	102	107	109	106	99	88
71-8-1,5 (2v)	40	60	68	73	75	72	65	54	100-8-15 (2v)	59	79	87	92	94	91	84	73
71-4-2	56	76	84	89	91	88	81	70	100-4-20	75	95	103	108	110	107	100	89
71-8-2 (2v)	41	61	69	74	76	73	66	55	100-8-20 (2v)	60	80	88	93	95	92	85	74
71-4-3	58	78	86	91	93	90	83	72	100-6-3	62	82	90	95	97	94	87	76
71-8-3 (2v)	43	63	71	76	78	75	68	57	100-12-3 (2v)	47	67	75	80	82	79	72	61
71-4-4	59	79	87	92	94	91	84	73	100-6-4	63	83	91	96	98	95	88	77
71-8-4 (2v)	44	64	72	77	79	76	69	58	100-12-4 (2v)	48	68	76	81	83	80	73	62
71-6-0,75	44	64	72	77	79	76	69	58	100-6-5,5	64	84	92	97	99	96	89	78
71-6-1	45	65	73	78	80	77	70	59	100-12-5,5 (2v)	49	69	77	82	84	81	74	63
71-12-1 (2v)	30	50	58	63	65	62	55	44	100-8-1,5	56	76	84	89	91	88	81	70
71-6-1,5	46	66	74	79	81	78	71	60	100-8-2	57	77	85	90	92	89	82	71
71-12-1,5 (2v)	31	51	59	64	66	63	56	45	100-8-3	57	77	85	90	92	89	82	71
80-4-3	59	79	87	92	94	91	84	73	100-8-4	58	78	86	91	93	90	83	72



Dimensiones mm

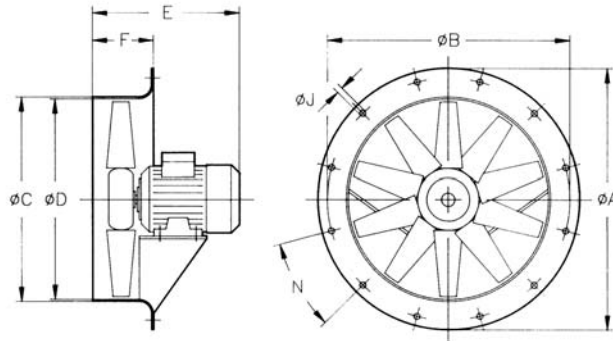

Modelo	ØA	ØB	ØC	ØD	E													F	ØJ	N		
					0,16	0,33	0,5	0,75	1	1,5	2	3	4	5,5	7,5	10	15				20	
HCH-35-2	425	395	358	355	-	-	285	-	-	-	-	-	-	-	-	-	-	-	-	110	10	8 X 45°
HCH-35-4	425	395	358	355	257	-	-	-	-	-	-	-	-	-	-	-	-	-	-	110	10	8 X 45°
HCH-40-2	490	450	414	410	-	-	-	-	-	314	-	-	-	-	-	-	-	-	-	120	12	8 X 45°
HCH-40-4	490	450	414	410	-	295	-	-	-	-	-	-	-	-	-	-	-	-	-	120	12	8 X 45°
HCH-45-4	540	500	464	460	-	-	280	-	-	-	-	-	-	-	-	-	-	-	-	120	12	8 X 45°
HCH-45-6	540	500	464	460	-	280	-	-	-	-	-	-	-	-	-	-	-	-	-	120	12	8 X 45°
HCH-56-4	660	620	564	560	-	-	-	310	310	330	350	-	-	-	-	-	-	-	-	120	12	12 X 30°
HCH-56-6	660	620	564	560	-	285	310	310	-	-	-	-	-	-	-	-	-	-	-	120	12	12 X 30°
HCH-63-4	730	690	645	640	-	-	-	-	325	325	355	405	405	-	-	-	-	-	-	150	12	12 X 30°
HCH-63-6	730	690	645	640	-	-	325	325	335	-	-	-	-	-	-	-	-	-	-	150	12	12 X 30°
HCH-71-4	810	770	715	710	-	-	-	-	-	330	350	415	415	-	-	-	-	-	-	150	12	16 X 22°30'
HCH-71-6	810	770	715	710	-	-	-	315	330	350	-	-	-	-	-	-	-	-	-	150	12	16 X 22°30'
HCH-80-4	900	860	805	800	-	-	-	-	-	-	-	425	425	445	-	-	-	-	-	180	12	16 X 22°30'
HCH-80-6	900	860	805	800	-	-	-	-	355	375	425	445	-	-	-	-	-	-	-	180	12	16 X 22°30'
HCH-80-8	900	860	805	800	-	-	380	380	410	-	-	-	-	-	-	-	-	-	-	180	12	16 X 22°30'
HCH-90-4	1015	970	906	900	-	-	-	-	-	-	-	425	430	465	465	-	-	-	-	180	15	16 X 22°30'
HCH-90-6	1015	970	906	900	-	-	-	-	-	-	425	430	465	-	-	-	-	-	-	180	15	16 X 22°30'
HCH-90-8	1015	970	906	900	-	-	-	-	410	410	395	460	-	-	-	-	-	-	-	180	15	16 X 22°30'
HCH-100-4	1115	1070	1006	1000	-	-	-	-	-	-	-	-	-	480	480	590	590	-	-	200	15	16 X 22°30'
HCH-100-6	1115	1070	1006	1000	-	-	-	-	-	-	-	440	480	480	-	-	-	-	-	200	15	16 X 22°30'
HCH-100-8	1115	1070	1006	1000	-	-	-	-	-	405	405	470	470	-	-	-	-	-	-	200	15	16 X 22°30'



Dimensiones mm

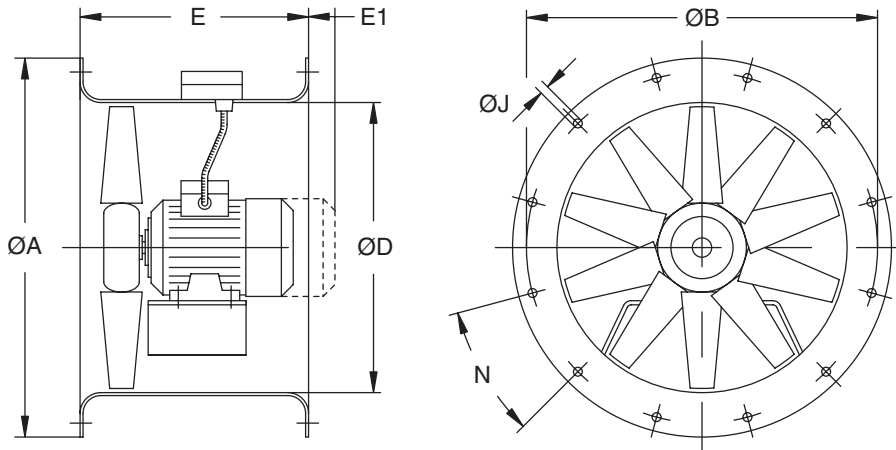

Modelo	ØA	ØB	ØD	E	E1	ØJ	N
HCT-25	310	280	240	230	10	10	4x90°
HCT-31	350	320	280	230	-	10	4x90°
HCT-35	425	395	355	230	-	10	8x45°
HCT-40	490	450	410	320	-	12	8x45°
HCT-45	540	500	460	360	-	12	8x45°
HCT-50	600	560	514	360	-	12	12x30°
HCT-56	660	620	560	400	-	12	12x30°
HCT-63	730	690	640	430	-	12	12x30°
HCT-71	810	770	710	500	-	12	16x22°30'
HCT-80	900	860	800	500	-	12	16x22°30'
HCT-90	1015	970	900	500	-	15	16x22°30'
HCT-100	1111	1070	1000	550	-	15	16x22°30'
HCT-100-4T-15	1115	1070	1000	650	-	15	16x22°30'
HCT-100-4T-20							



Curvas Características

Q = Caudal en m³/h y m³/s.

Pe = Presión estática en mm.c.a. y Pa.

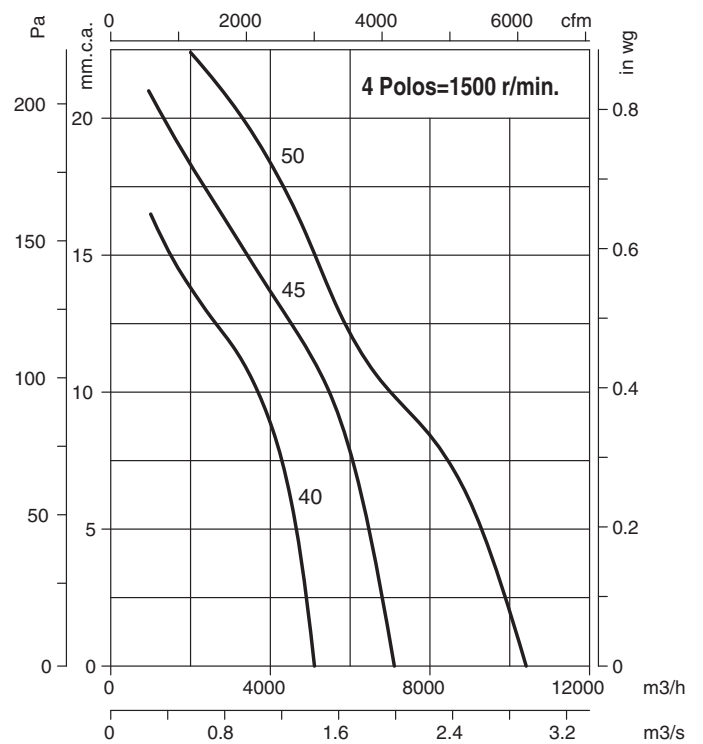
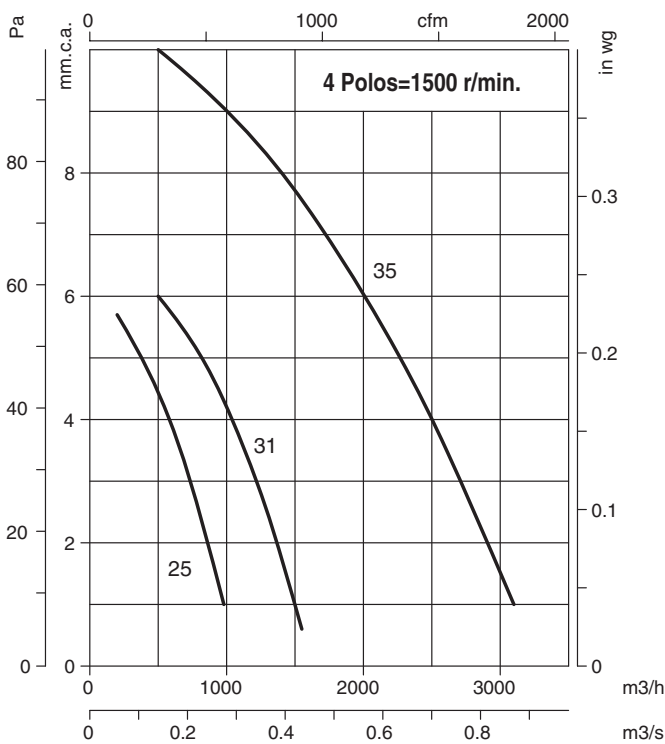
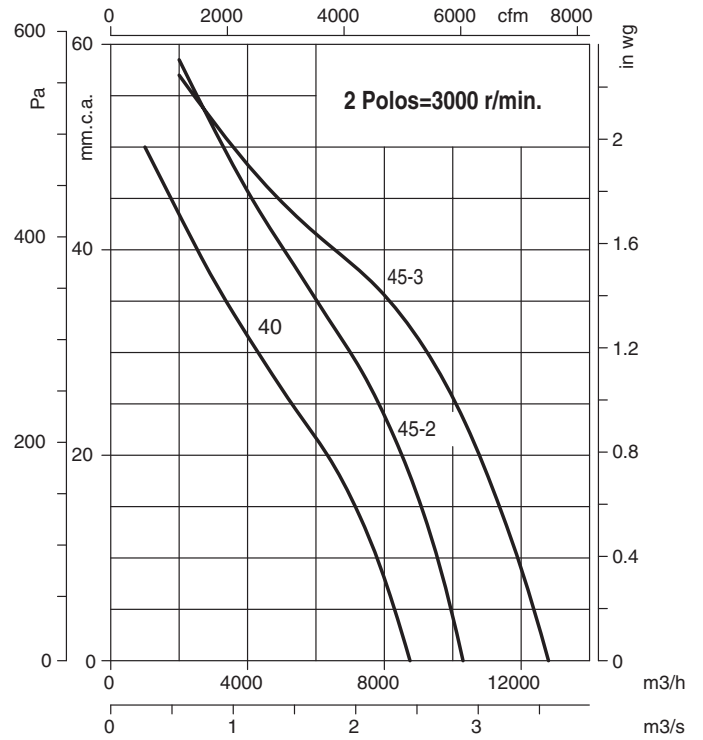
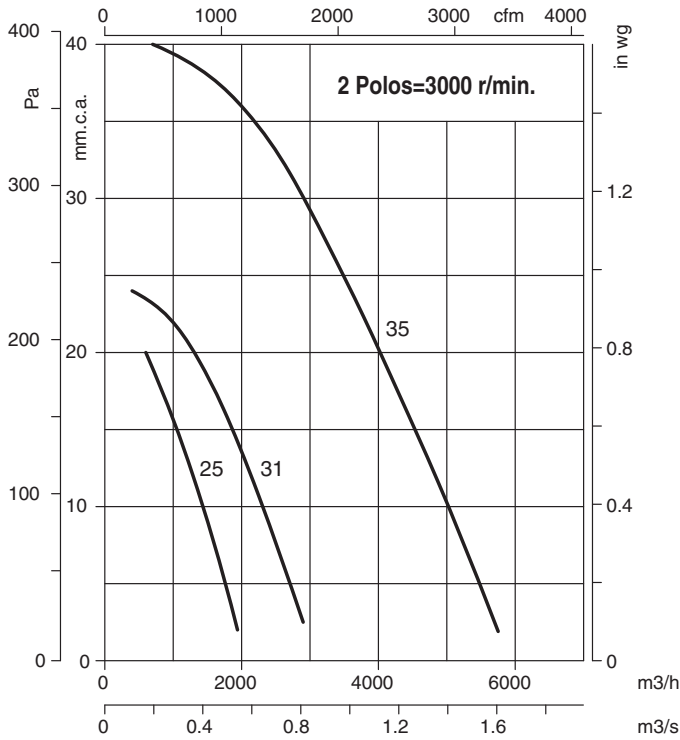



Curvas Características

Q = Caudal en m³/h y m³/s.

Pe = Presión estática en mm.c.a. y Pa.

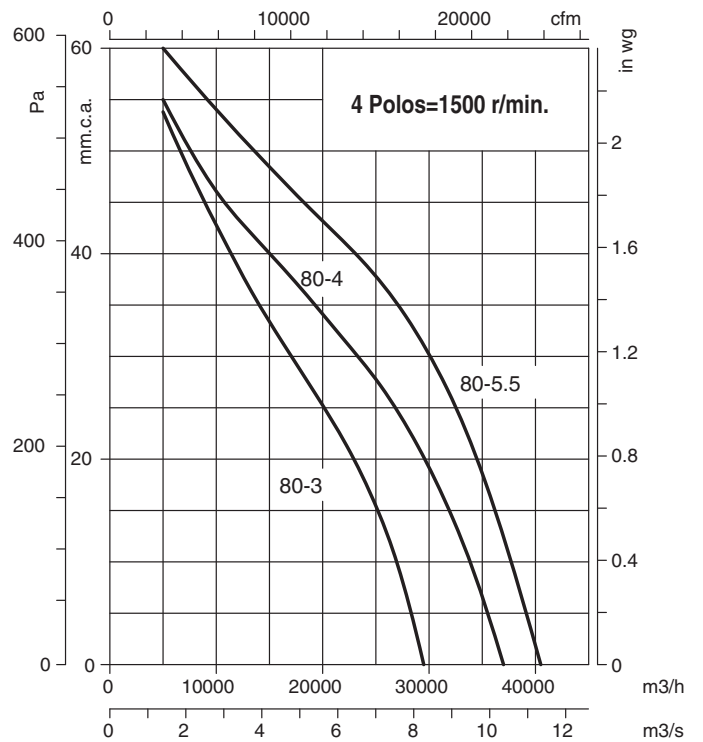
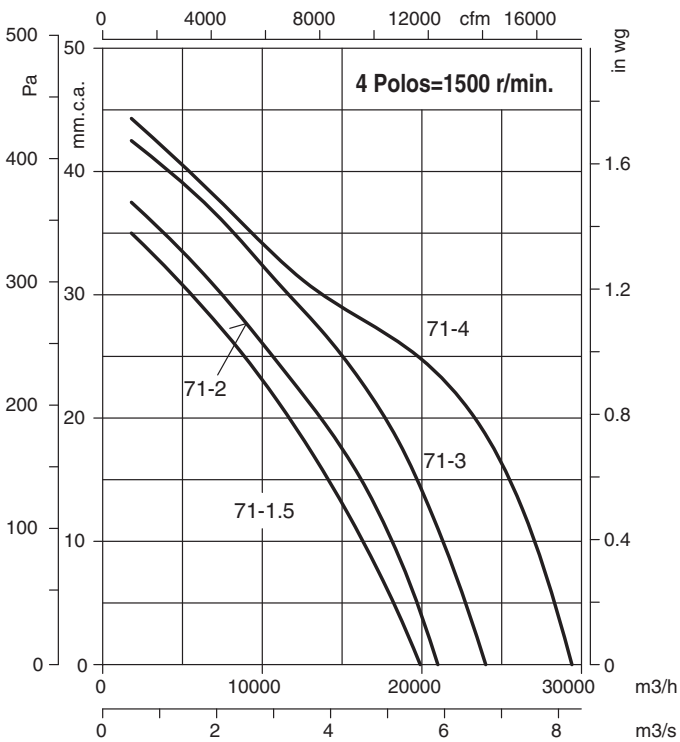
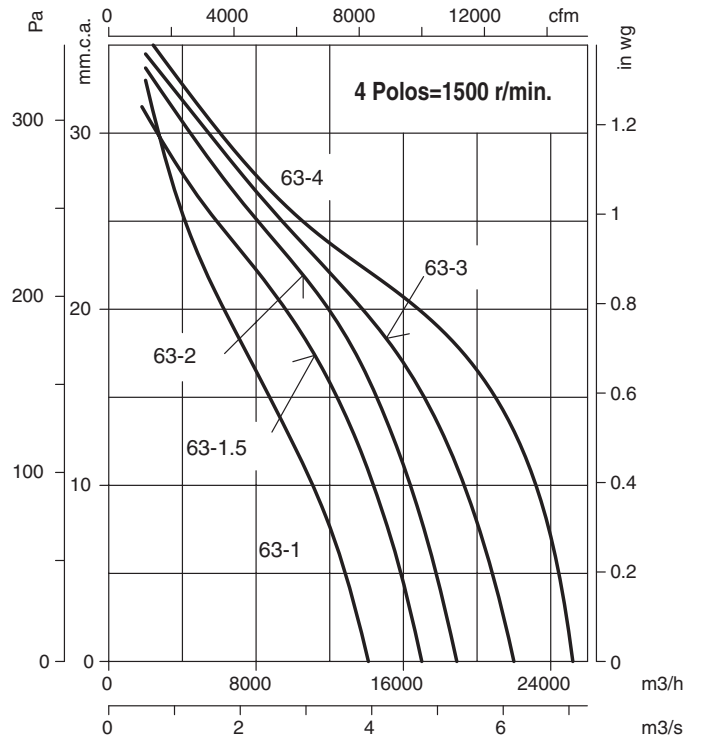
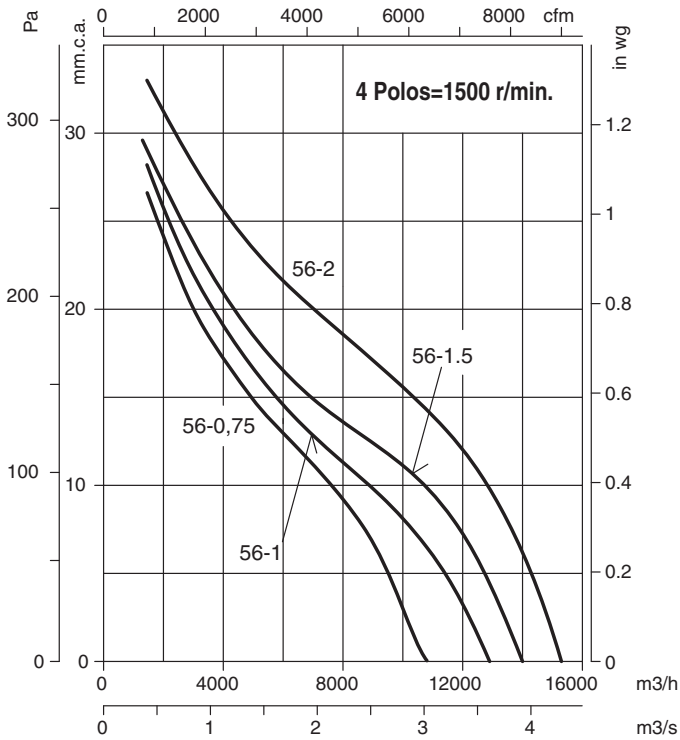



Curvas Características

Q = Caudal en m³/h y m³/s.

Pe = Presión estática en mm.c.a. y Pa.

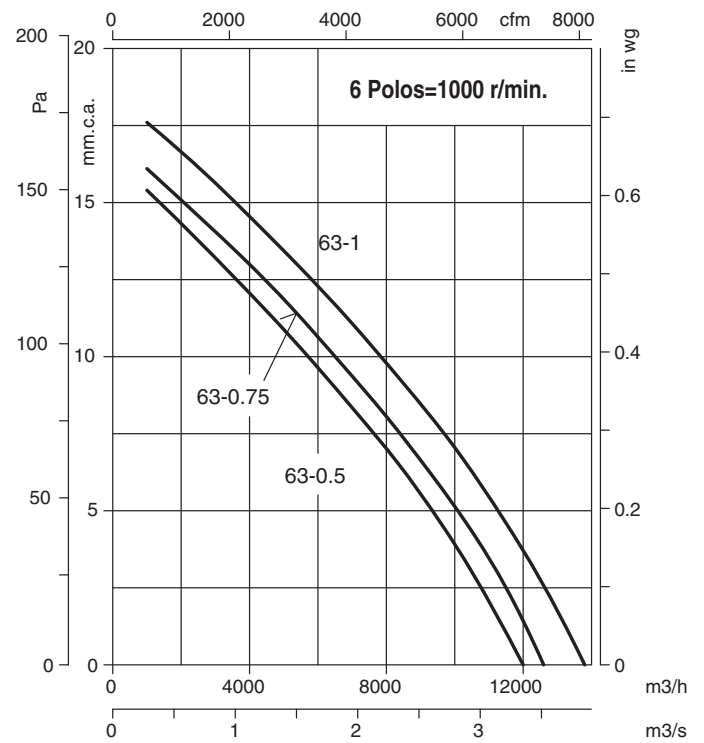
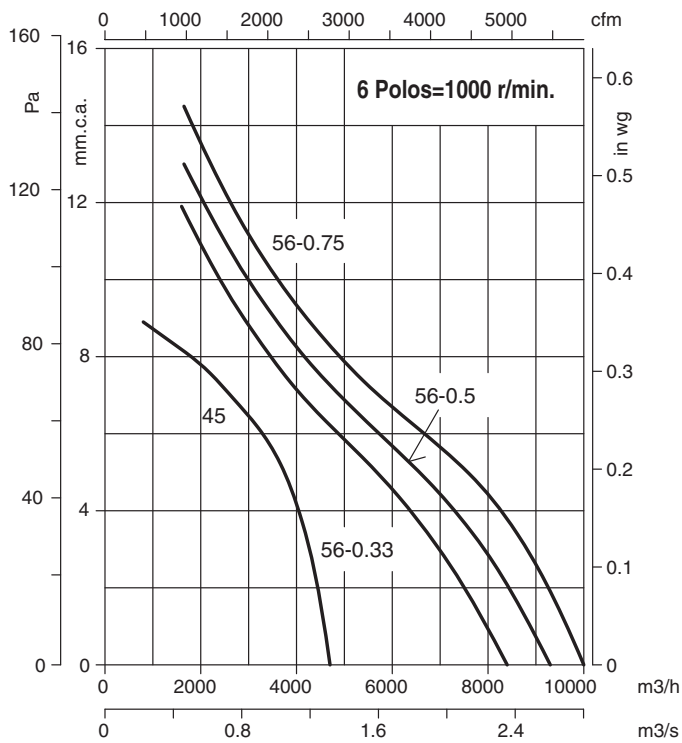
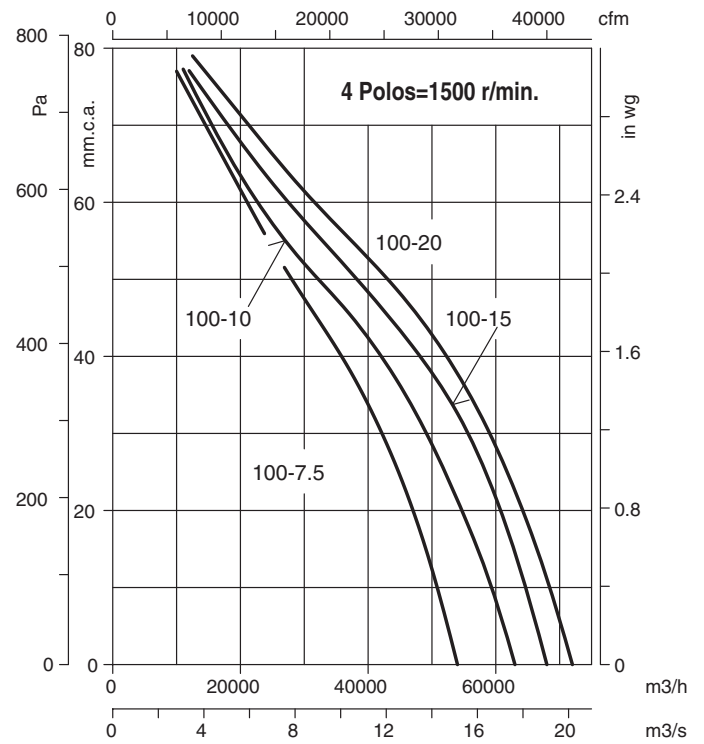
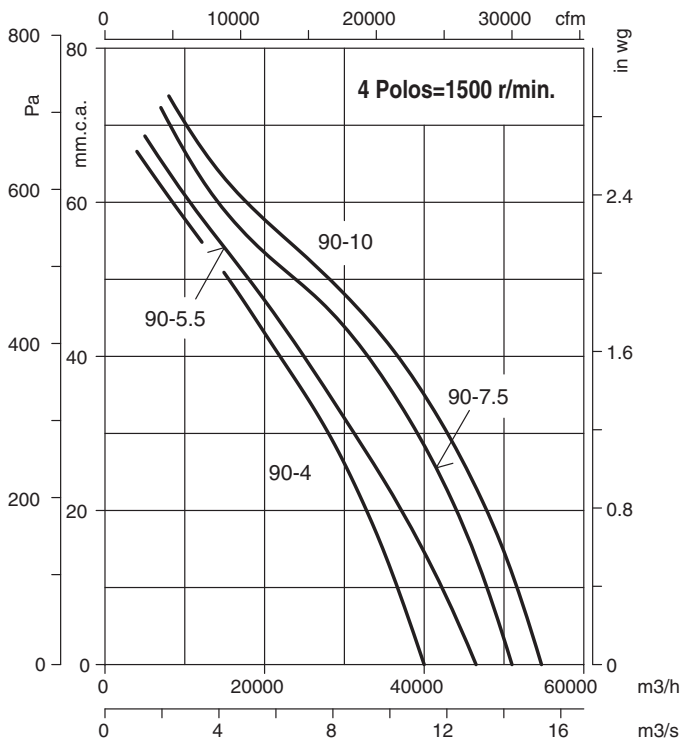



Curvas Características

Q = Caudal en m³/h y m³/s.

Pe = Presión estática en mm.c.a. y Pa.

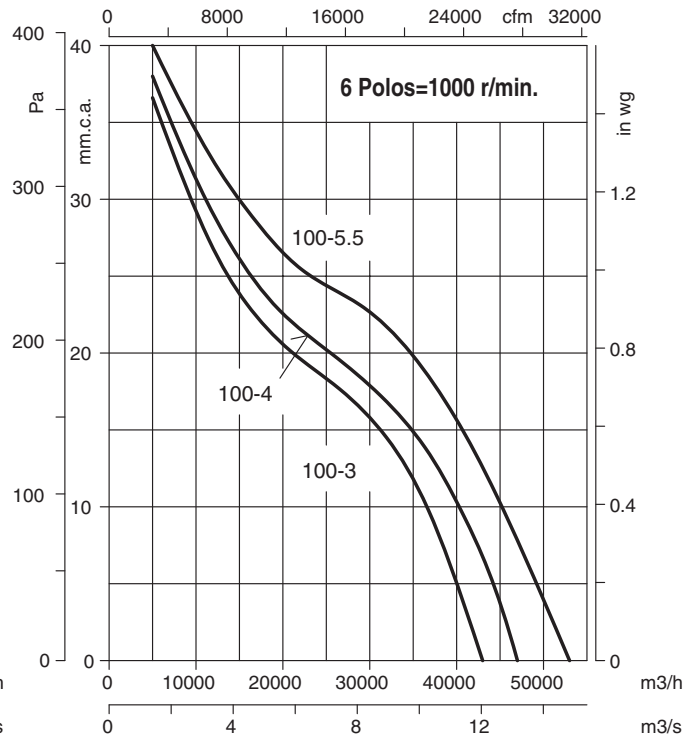
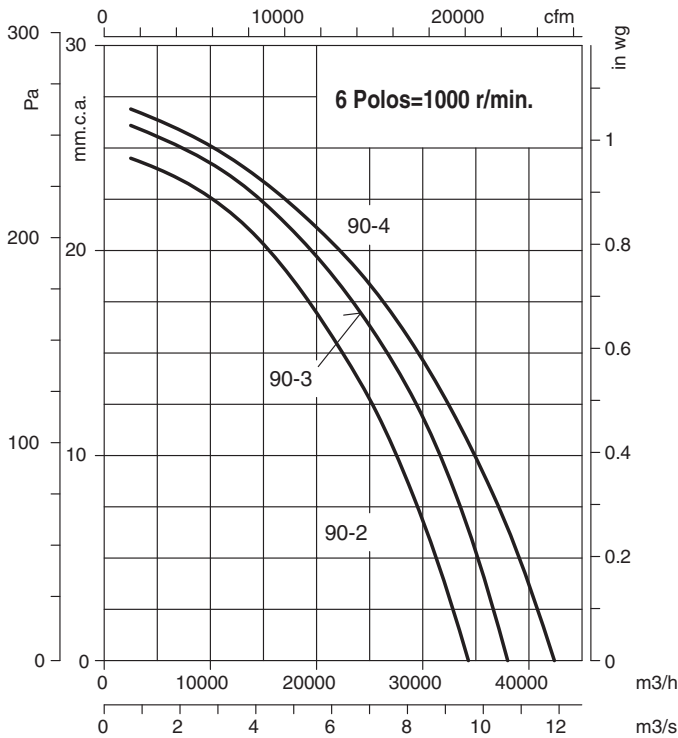
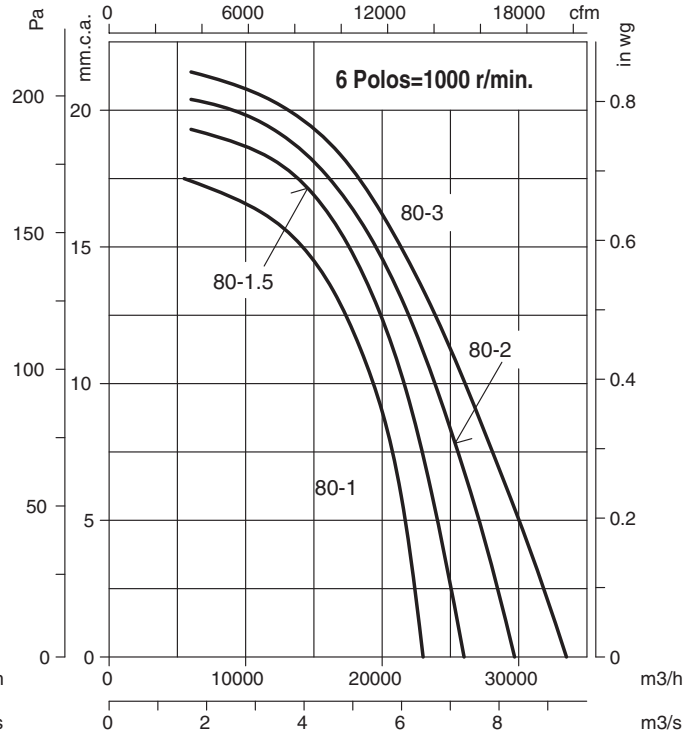
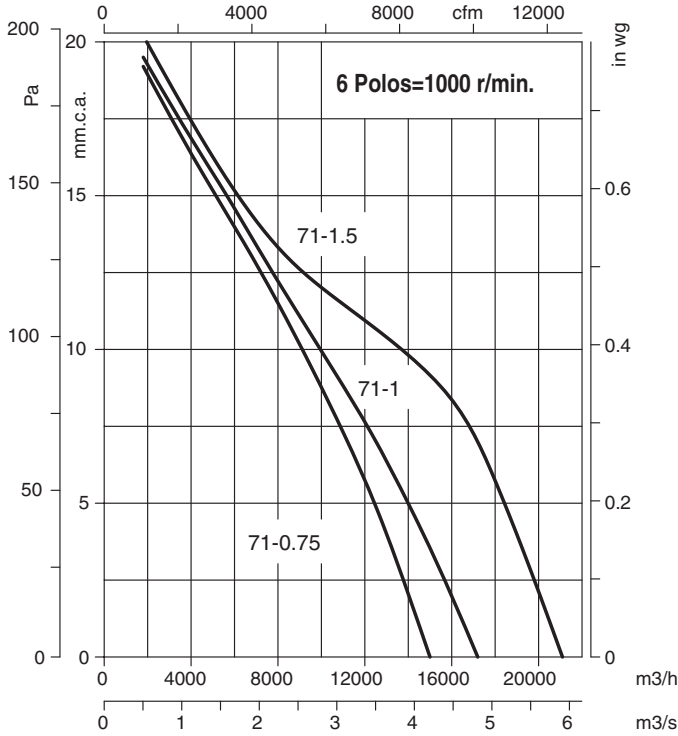



Curvas Características

Q = Caudal en m³/h y m³/s.

Pe = Presión estática en mm.c.a. y Pa.

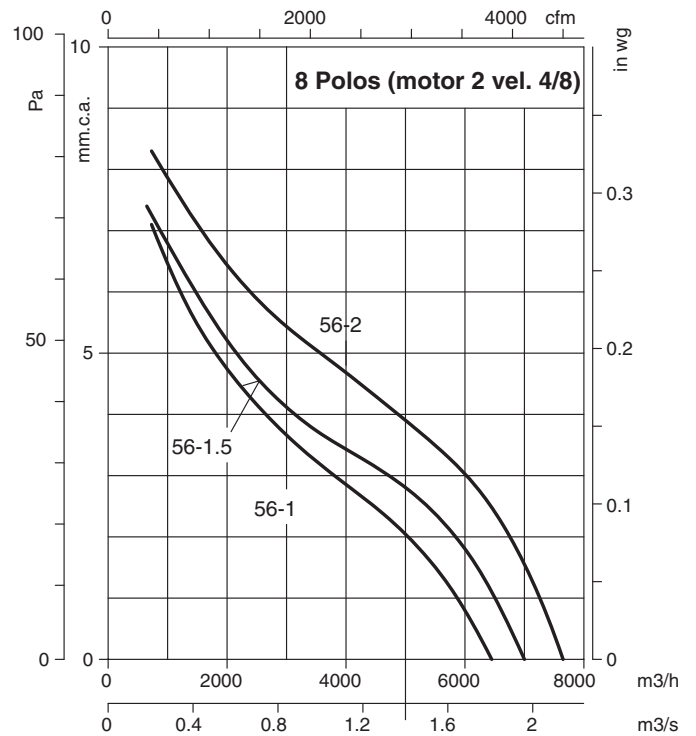
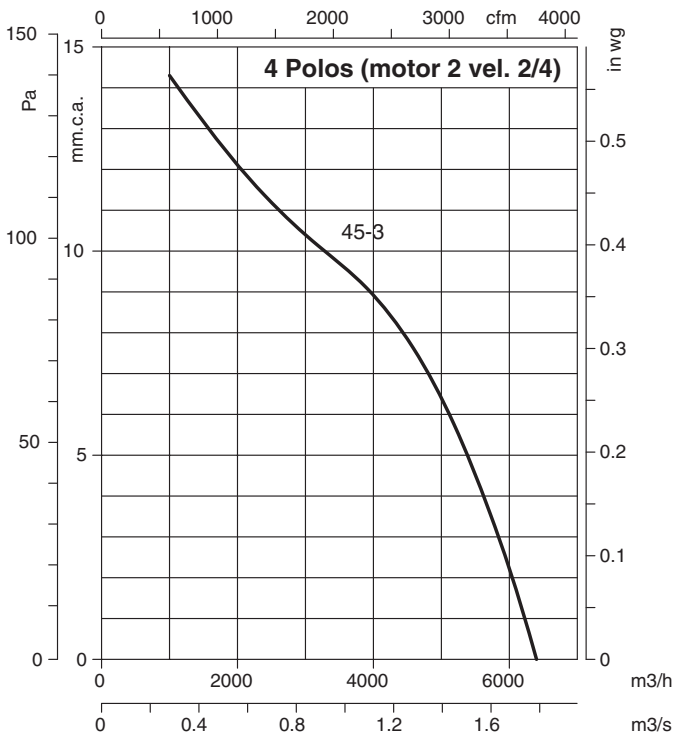
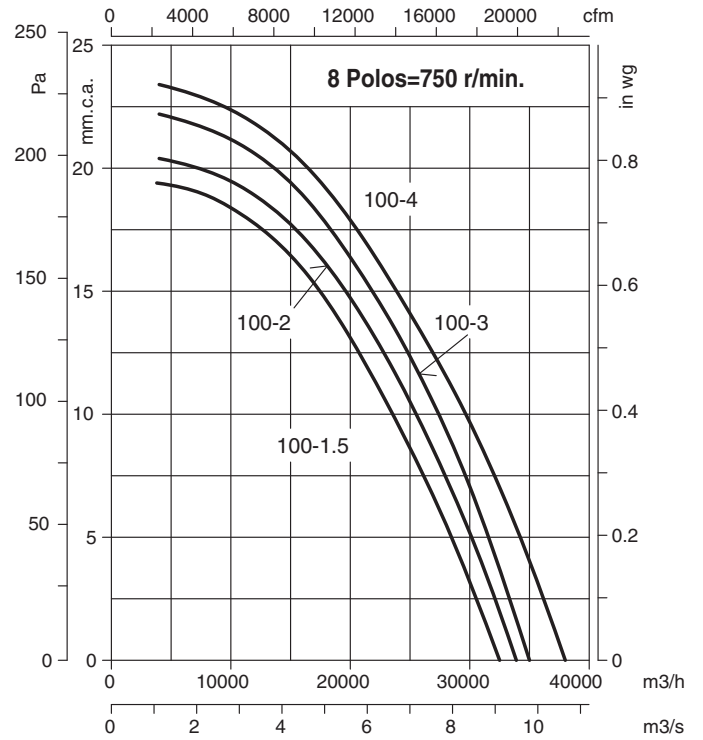
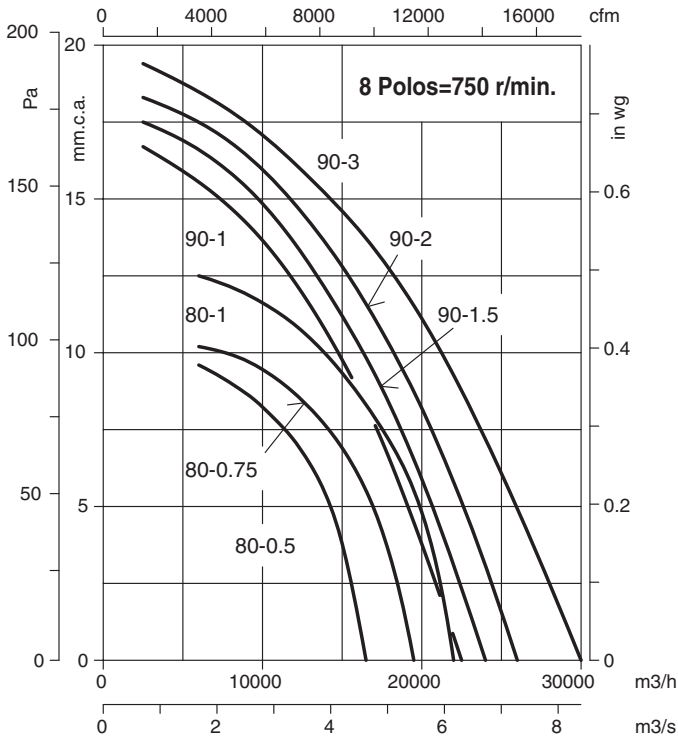



Curvas Características

Q = Caudal en m³/h y m³/s.

Pe = Presión estática en mm.c.a. y Pa.

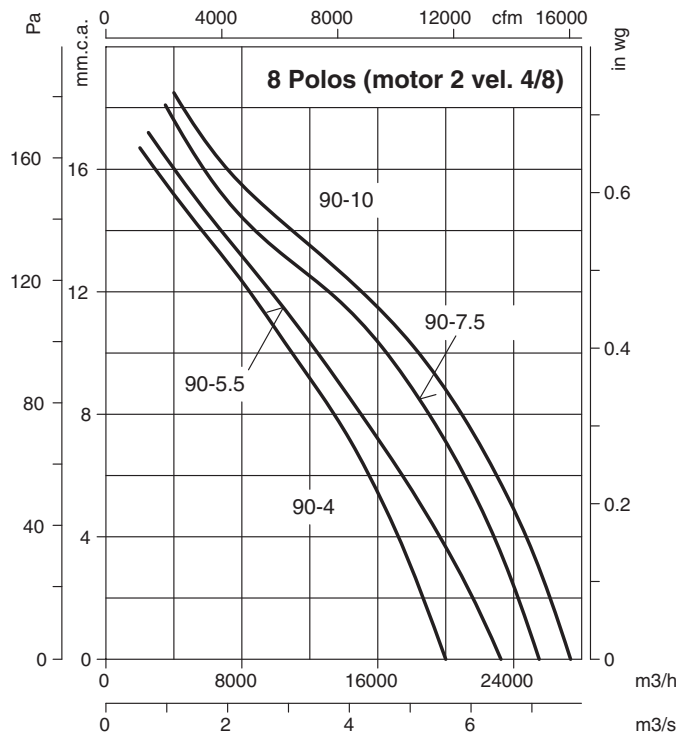
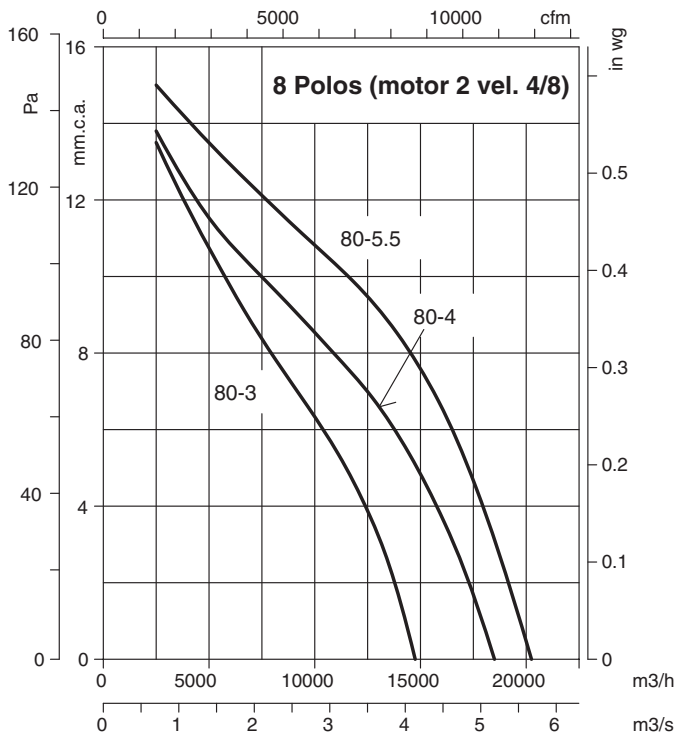
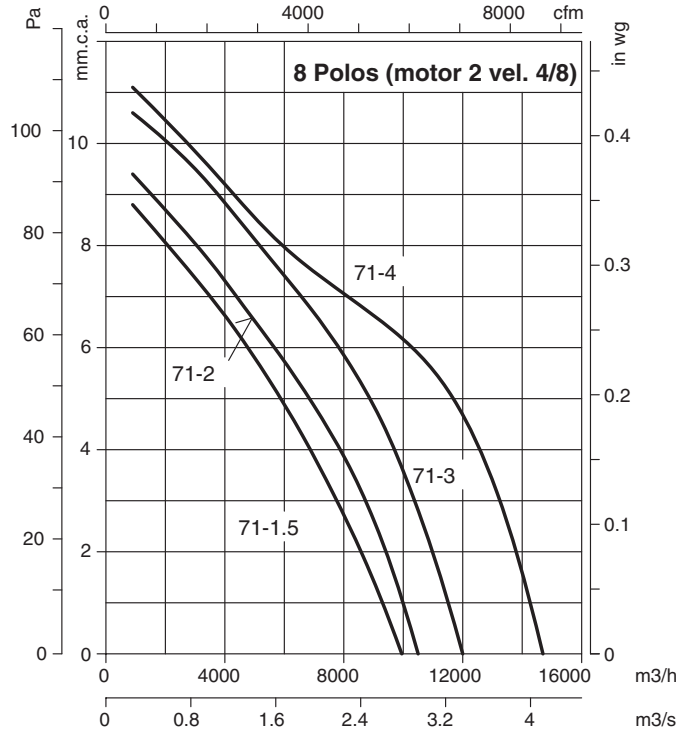
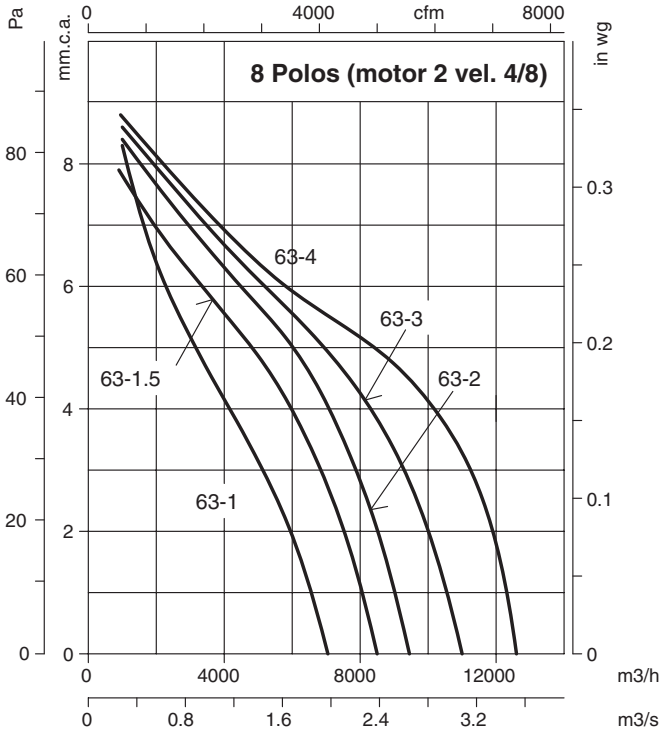



Curvas Características

Q = Caudal en m³/h y m³/s.

Pe = Presión estática en mm.c.a. y Pa.

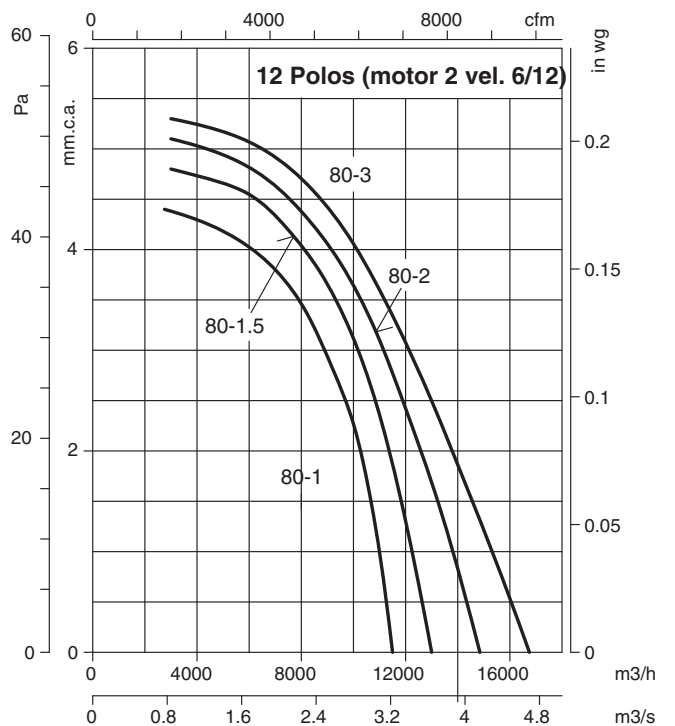
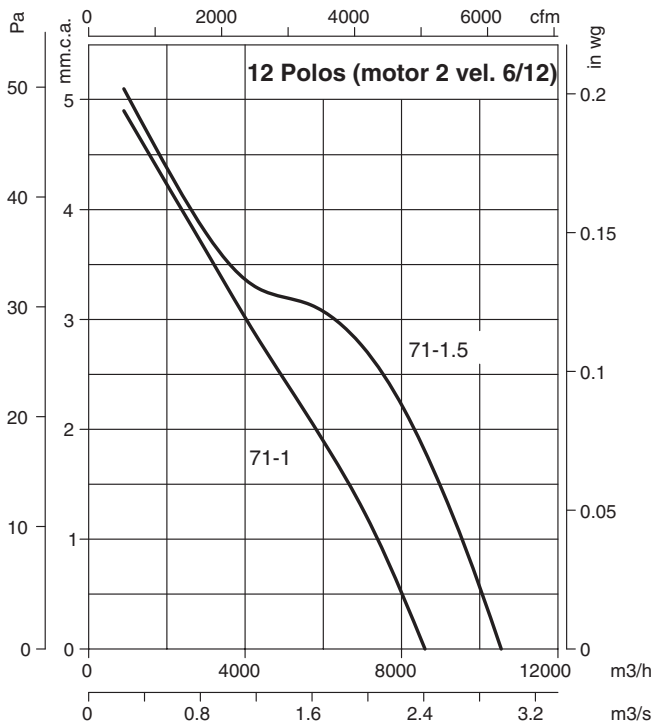
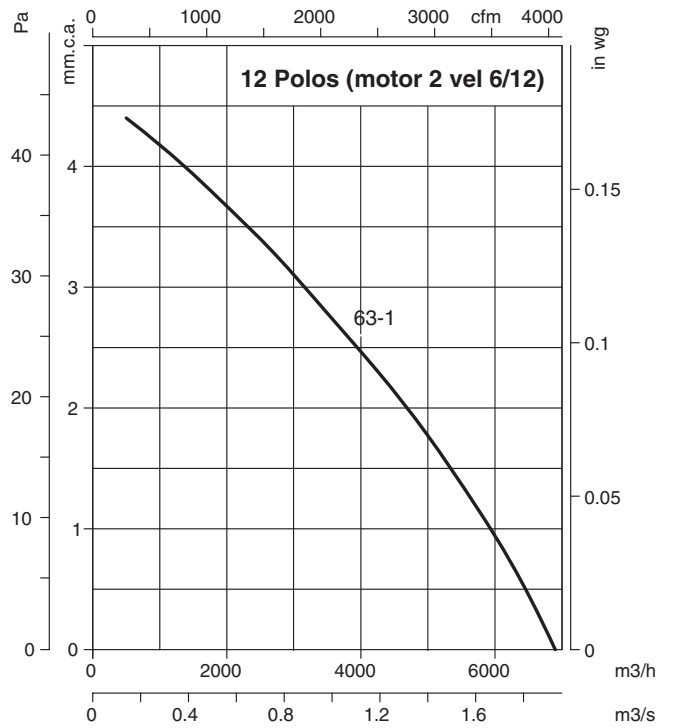
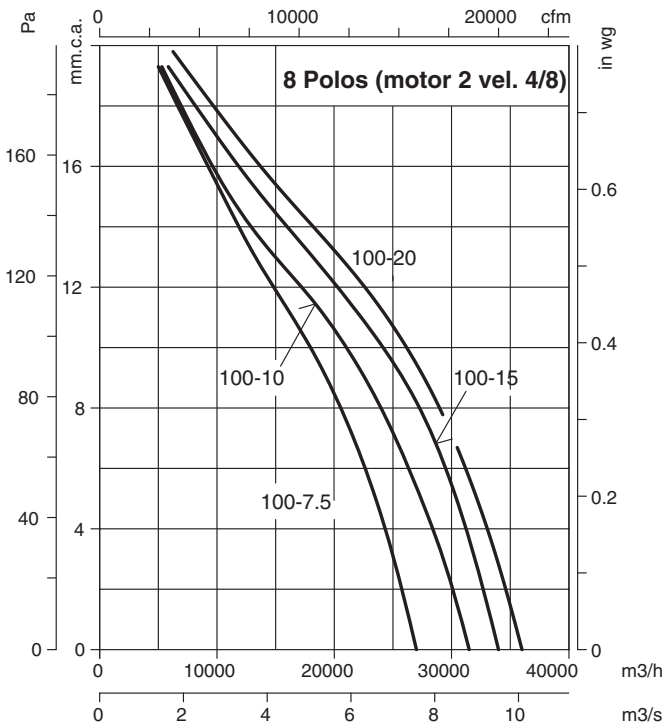



Curvas Características

Q = Caudal en m³/h y m³/s.

Pe = Presión estática en mm.c.a. y Pa.

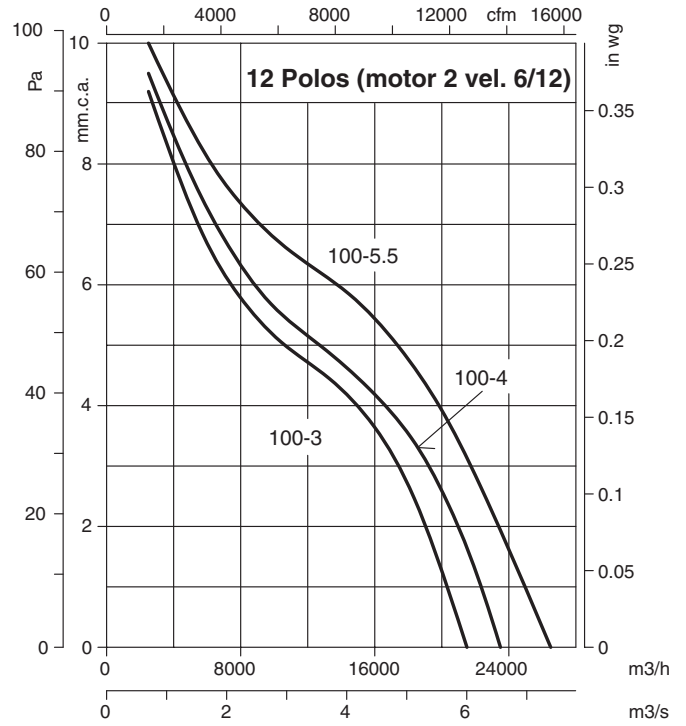
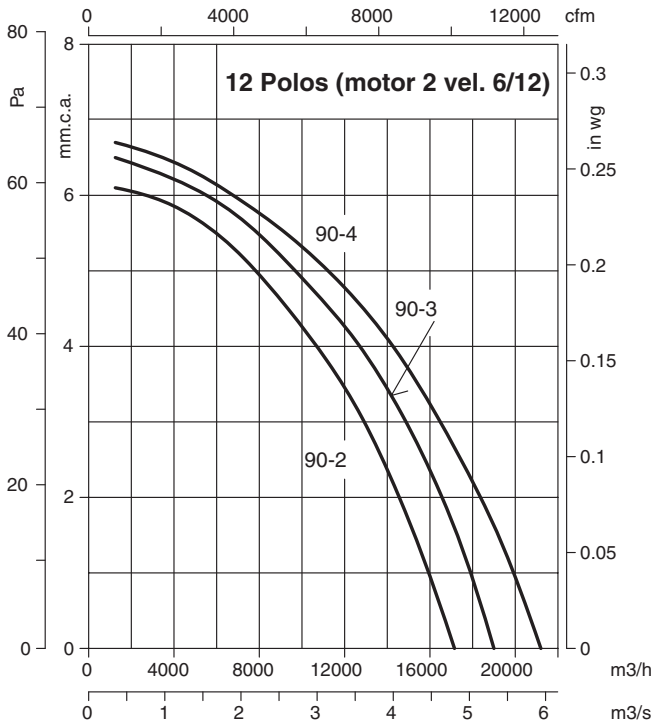

Accesorios

Ver apartado accesorios.

HCH



HCT

